

UV LED LAMP SPECIFICATION

Model: NS375L-5RLO

Nitride Semiconductors Co., Ltd.

1. Name: UV LED LAMP

2. Model: NS375L-5RLO

3. Absolute maximum ratings (Ta=25°C)

Item	Symbol	Maximum rating	Unit
DC Forward current	I _F	25	mA
Pulse forward current* ¹	I _{FP}	100	mA
Power dissipation	P _D	100	mW
Operating temperature	T _{OPR}	-30 to +80	°C
Storage temperature	T _{STG}	-30 to +85	°C
Soldering temperature	T _{SOL}	260°C within 10 seconds	

*¹ Conditions: Duty cycle \leq 1/10, Pulse width \leq 0.1msec

4. Optical and electrical characteristics (Ta=25°C)

Item		Symbol	Condition	Min.	Typ.	Max.	Unit
Forward voltage		V _F	I _F =20mA	3.2	3.6	4.2	V
Peak wavelength* ²		λ_p	I _F =20mA	375	-	380	nm
Full width at half maximum		$\Delta\lambda$	I _F =20mA	10	-	20	nm
Optical output power * ³	Rank 10 & 11	P _O	I _F =20mA	8.4	-	14.0	mW

*² Measurement error: \pm 2nm

*³ Measurement error: 10%

The percentage of each rank in the shipment shall be determined by Nitride Semiconductors.

5. Standard optical and electrical characteristics

To be hereinafter described.

6. Dimensional outline and materials (This product complies with RoHS.)

To be hereinafter described.

7. Reliability

(1) Test items and the results

• Mechanical test results

Test items	Test conditions	Notes	Test results	
			LTPD	Damages
Terminal strength (Pulling/Pushing)	Load 5N (Pulling) Load 1N(Pushing)	For 10 seconds each	50%	0/5
Terminal strength (Bending)	Load 2.5N 0°to 90°to 0° to reverse direction 90°to 0°	One time	50%	0/5
Dropping damage	Dropping from 1m high	Two times	20%	0/11

• Environmental test results

Test items	Test conditions	Notes	Test results	
			LTPD	Damages
Resistance to soldering heat	Tsol=260±5°C, 10 seconds At 1.5mm from the lead base	One time	10%	0/22
Resistance to soldering heat	Tsol=350±5°C, 3 seconds At 1.5mm from the lead base	One time	10%	0/22
Solderability	Tsol=235±5°C, 5 seconds (using flux)	One time Wetting more than 95%	20%	0/11

• Life test results

Test items	Test conditions	Notes	Test results	
			LTPD	Damages
Steady state operating life	Ta=25±2°C, IF=20mA	1000 hours	10%	0/22
Operating life at high temperature	Ta=80±2°C, IF=10mA	1000 hours	10%	0/22
Storage at high temperature	Ta=85±2°C	1000 hours	10%	0/22
Operating life at low temperature	Ta=-30±2°C, IF=15mA	1000 hours	10%	0/22
Operating life at high temperature and humidity	Ta=60±2°C, RH=90±5%, IF=15mA	500 hours	10%	0/22
Storage at high temperature and humidity	Ta=60±2°C, RH=90±5%	500 hours	10%	0/22

(2) Criteria for judging damages

Test items	Symbols	Measurement conditions	Judgment criteria	
			Min.	Max.
Forward voltage	VF	IF=20mA	-	(U)×1.1
Optical output power	Po	IF=20mA	(L)×0.5	-

*(U): Upper standard level, (L): Lower standard level

8. Cautions

- (1) The LEDs emit strong UV radiation. Do not look directly at the LEDs. UV radiation may harm your eyes. To prevent inadequate exposure of UV radiation, wear UV protective glasses.
- (2) Direction for use
When designing the circuit, the current through each LED must not exceed the absolute maximum ratings. Operating at a constant current per LED is recommended.
This product should be operated using forward current. Do not apply either forward or reverse voltage while it is not in use.
- (3) Static and surge
The LEDs are very sensitive to static electricity and surge voltage. Take a full protection against static and surge.
- (4) Heat generation
The powered LEDs generate heat. The operating current should be decided after considering the ambient maximum temperature of LEDs.
- (5) Lead forming
Lead forming should be done before soldering. When forming leads, the leads should be bent at a point at least 1.5mm from the base of header and must be taken to avoid any stress. When mounting the LEDs onto a PCB, the holes on the circuit board should be exactly aligned with the leads of the LEDs. The LEDs should be soldered at least 1.5mm from the base of header.
- (6) Storage
The leads are silver plated. They may be changed in quality by exposing to the air contains corrosive gas. Be careful with the storage environment. The LEDs in the sealed bag can be stored for maximum 6 months. For the storage more than 6 months up to 1 year, the LEDs should be stored in the suitable environment of the stable temperature and humidity.
- (7) This LED also emits the visible light. Please take notice of the visible light spectrum in case of use for especially sensors.

9. Warranty

- (1) The warranty is valid for UV LED lamps only.
- (2) Perform an acceptance inspection on arrival of the goods. Return the defectives if any stipulating the disqualification and quantity.
- (3) Embedding the LEDs into the application and the verification of life and other qualities in practical use shall be executed by user.
- (4) The LEDs are intended to be used for ordinary electronics equipment. Do not use the LEDs for the applications that require the higher reliability and security and that may endanger life and health by the breakdown and the malfunction. Seller shall not bear any responsibility or liability with respect to any claims and damages caused by user's usage of the LEDs without following our intended purpose or any written consent.
- (5) Seller shall not bear responsibility for any damages or defects caused by improper operation at the current in excess of the absolute maximum ratings that are not covered by warranty.

10. Others

- (1) The technical information in this specification is not to guarantee the intellectual property rights of seller's nor a third party and not to grant the license.
- (2) The appearance and specifications may be modified for improvement without notice.
Do not reverse engineering by disassembling or analysis of the LEDs without our consent. If there's any defectives found, please contact our sales division.

Optical and electrical characteristics

■ Forward voltage vs. Forward current

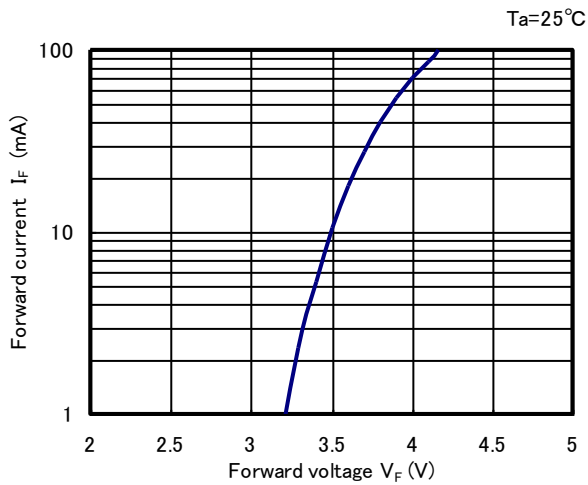

■ Forward current vs. Relative output power

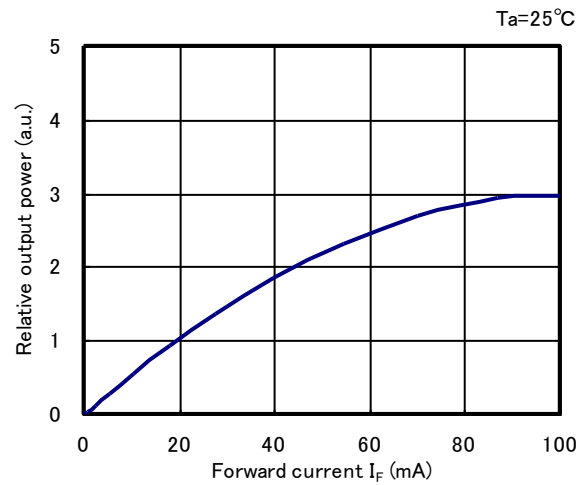

■ Ambient temperature vs. Relative output power

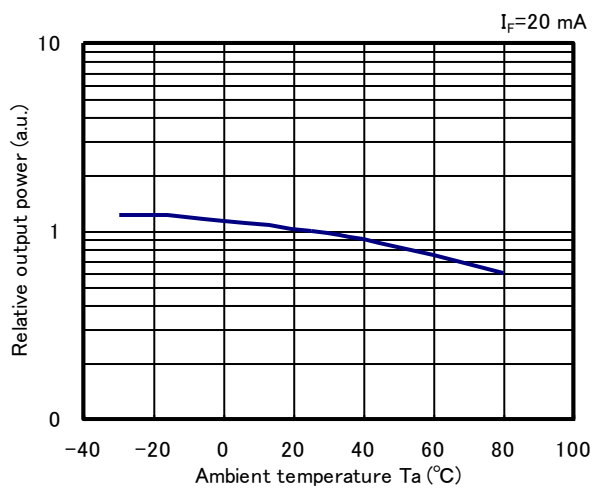

■ Ambient temperature vs. Forward voltage

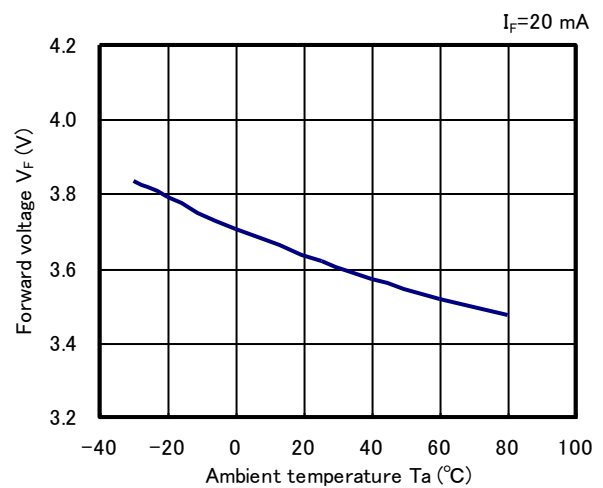

■ Ambient temperature vs.
Allowable forward current

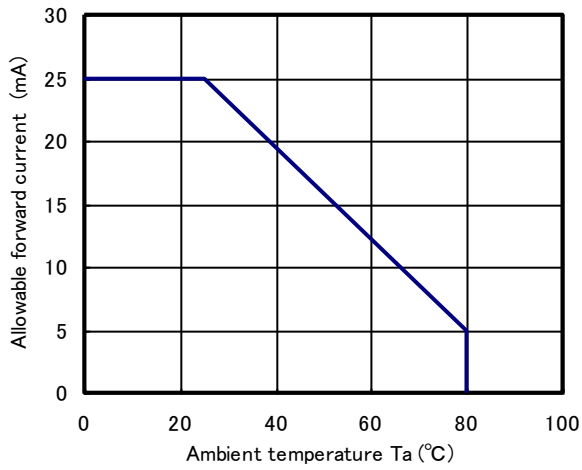

■ Spectrum

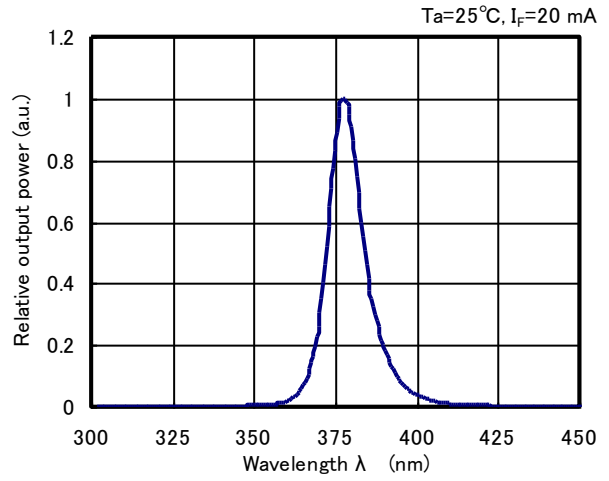

■ Directivity

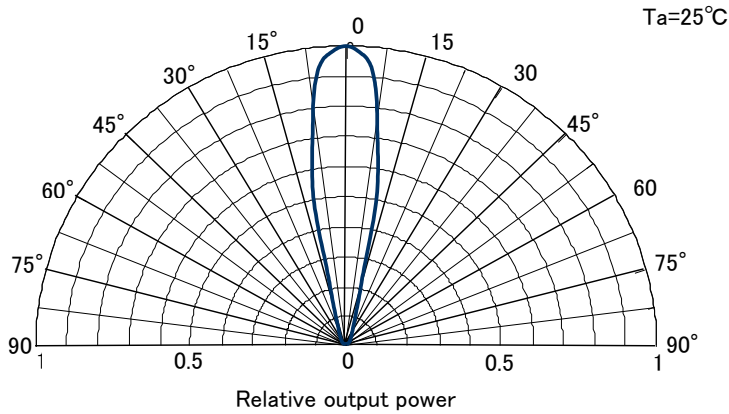

■ Dimensional outline drawing

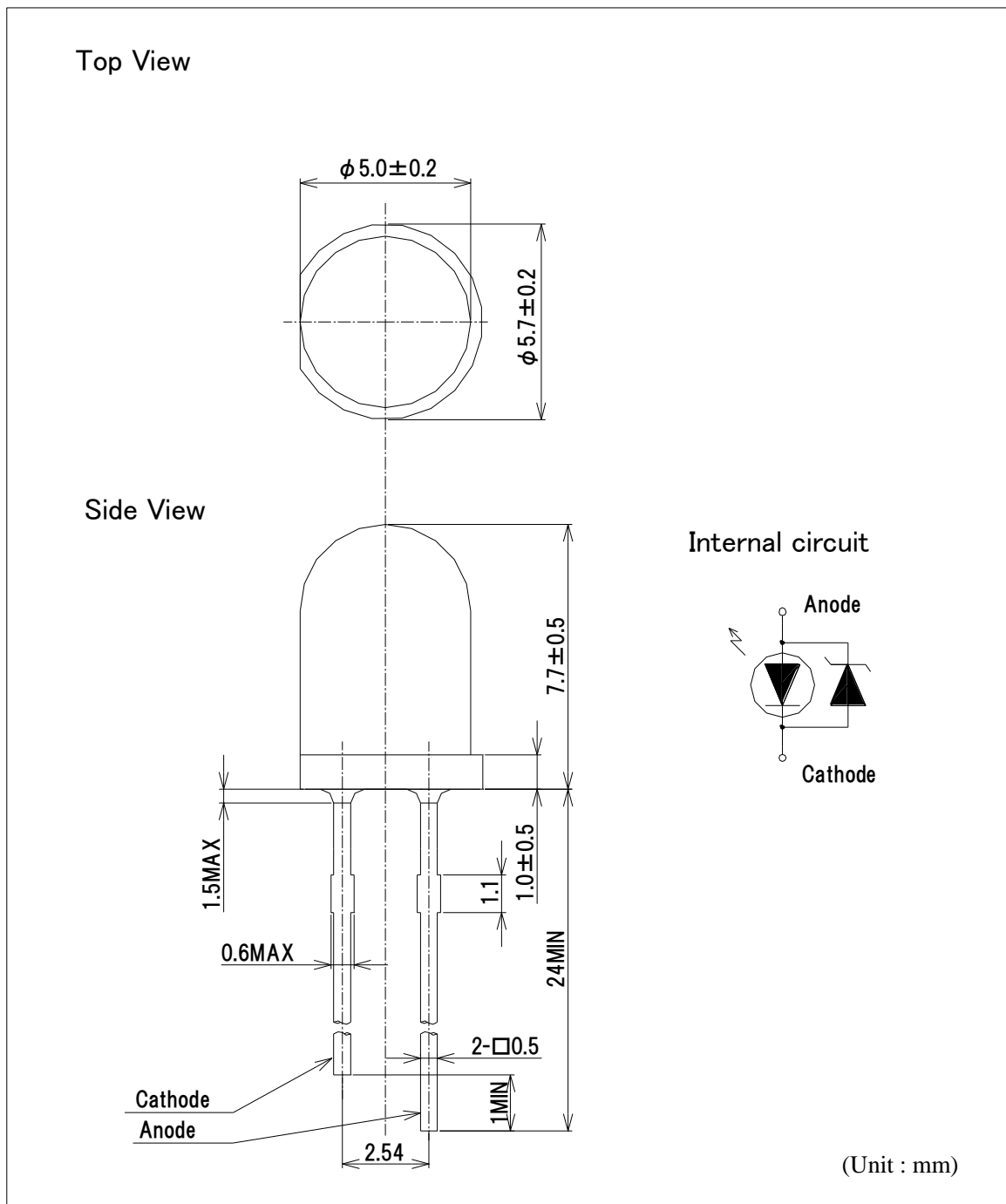

*A zener diode is built in the protective circuit against static electricity.

Item	Material
Encapsulating Resin	Silicone resin
Lead Frame	Fe + Ag coating